

## ANSI 900# Female Ring Joint

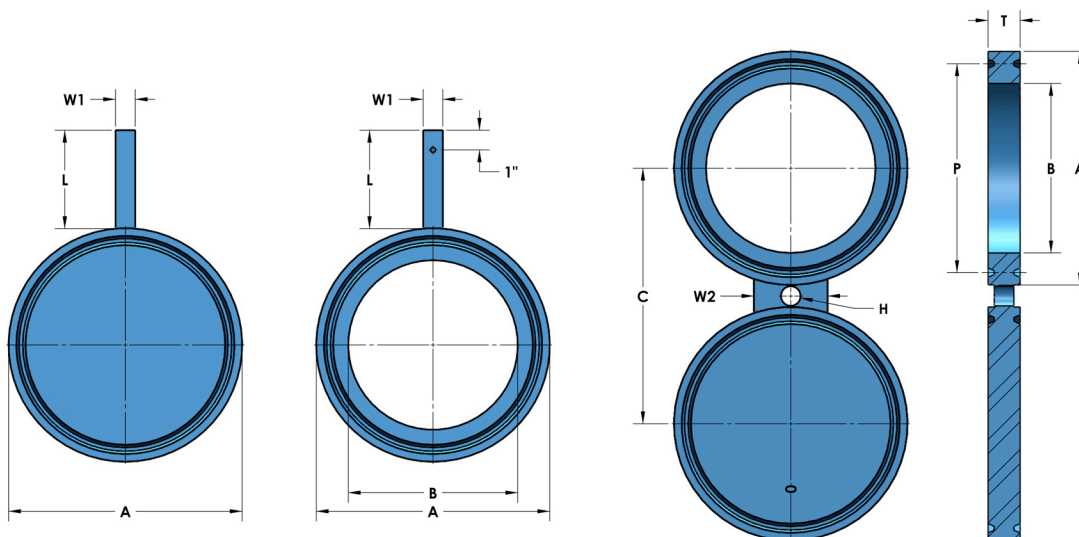

Type 1  
Paddle Blind

Type 1A  
Paddle Spacer

Type 2  
Spectacle Blind

Dimensional Data (in)											Approximate Weights (lbs)		
Size	A	B	C	T	P	L	W1	W2	H	Ring	1	1A	2
1/2	2.38	0.84	3.25	0.88	1.562	5	1.0	1.50	0.875	R 12	1	1	1
3/4	2.62	1.05	3.50	0.88	1.750	5	1.0	1.75	0.875	R 14	2	2	2
1	2.81	1.32	4.00	0.88	2.000	5	1.0	2.00	1.000	R 16	3	3	4
1 1/4	3.19	1.66	4.38	1.00	2.375	5	1.0	2.00	1.000	R 18	4	3	5
1 1/2	3.62	1.90	4.88	1.00	2.688	5	1.0	2.50	1.125	R 20	5	4	6
2	4.88	2.38	6.50	1.25	3.750	5	1.0	2.00	1.000	R 24	8	7	13
2 1/2	5.38	2.88	7.50	1.38	4.250	6	1.0	2.62	1.125	R 27	11	8	18
3	6.12	3.50	7.50	1.38	4.875	6	1.0	2.62	1.000	R 31	13	9	21
4	7.12	4.50	9.25	1.62	5.875	6	1.0	2.88	1.250	R 37	20	13	30
5	8.50	5.56	11.00	1.75	7.125	6	1.0	2.88	1.375	R 41	32	25	45
6	9.50	6.62	12.50	1.88	8.312	6	1.0	2.88	1.250	R 45	41	22	60
8	12.12	8.62	15.50	2.25	10.625	7	1.0	3.12	1.500	R 49	77	40	112
10	14.25	10.75	18.50	2.50	12.750	7	1.0	4.75	1.500	R 53	119	53	169
12	16.50	12.75	21.00	2.88	15.000	7	1.5	4.75	1.500	R 57	178	74	249
14	18.38	14.00	22.00	3.25	16.500	7	1.5	4.75	1.625	R 62	252	108	546
16	20.62	16.00	24.25	3.62	18.500	7	1.5	5.00	1.750	R 66	347	140	484
18	23.38	18.00	27.00	4.00	21.000	8	1.5	5.25	2.000	R 70	505	208	712
20	25.50	20.00	29.50	4.38	23.000	8	1.5	5.00	2.125	R 74	646	251	898
24	30.38	24.00	35.50	5.25	27.250	8	1.5	5.50	2.625	R 78	1094	413	1512